



Technical description

Application:

Heating and cooling systems with variable flow.
District heating substations, primary side.

Functions:

Differential pressure control over the load.

Pressure class:

DN 32-125: PN 16 (PN 25 on request).
DN 150-200: PN 25

Max. differential pressure:

1600 kPa = 16 bar

Temperature:

Max. working temperature: 150°C
Min. working temperature: -10°C

Setting range:

Δp is adjustable within 10-60 kPa.
(50-150 kPa and 120-250 kPa on request).
Delivery setting: 10 kPa. (50 kPa respectively 120 kPa).

Media:

Water and neutral fluids, water-glycol mixtures.

Material:

Valve body:
PN 16: Cast iron EN-GJL-250
PN 25: Ductile iron EN-GJS-400-18LT
Actuator body: Ductile iron EN-GJS-400-18LT
Diaphragms: EPDM
Valve plug: Stainless steel with EPDM insert.
Valve seat: Stainless steel.

Surface treatment:

Duasolid painting.

Marking:

TA, DN, PN and flow direction arrow.

Flanges:

DN 32-50: According to EN-1092-2:1997, type 16.
DN 65-200: According to EN-1092-2:1997, type 21.

DA 50

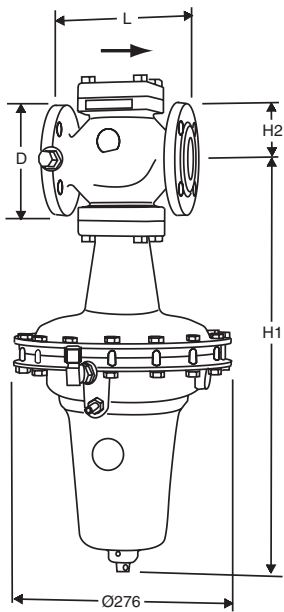

10-60 kPa, PN 16

TA No	DN	D	L	H1	H2	Kvs	$q_{r\min}$ m ³ /h	$q_{r\max}$ m ³ /h	Kg
52 750-532	32	140	180	540	102	21	0,8	7,2	38
52 750-540	40	150	200	540	120	25	0,8	9,6	39
52 750-550	50	165	230	570	135	32	1,0	15	46
52 750-565	65	185	290	580	150	55	1,5	28	55
52 750-580	80	200	310	670	170	70	2,5	38	66
52 750-590	100	235	350	690	225	120	4,0	57	88
52 750-591	125	270	400	700	235	145	5,0	88	105

10-60 kPa, PN 25

TA No	DN	D	L	H1	H2	Kvs	$q_{r\min}$ m ³ /h	$q_{r\max}$ m ³ /h	Kg
52 750-592	150	300	480	770	270	230	15	125	235
52 750-593	200	360	600	800	310	240	20	240	297
52 750-594	200	360	600	800	310	360	20	345	297

Capillary pipe (Ø10) included: 2 500 mm

→ = Flow direction

Operating function

The controller consists of a valve (1) and a diaphragm actuator (3). The valve is protected against overload with a safety spring (2). The pressure upstream of the load acts through an external capillary pipe ($\Delta p+$) to the bottom side of the diaphragm and attempts to close the valve.

The pressure downstream of the load acts through an internal capillary pipe ($\Delta p-$) to the top side of the diaphragm and attempts to open the valve together with the force of the working spring (5).

As long as the forces on the diaphragm are balanced, the valve's plug stands still. If the differential pressure rises, the valve closes until new balance is reached, and vice versa.

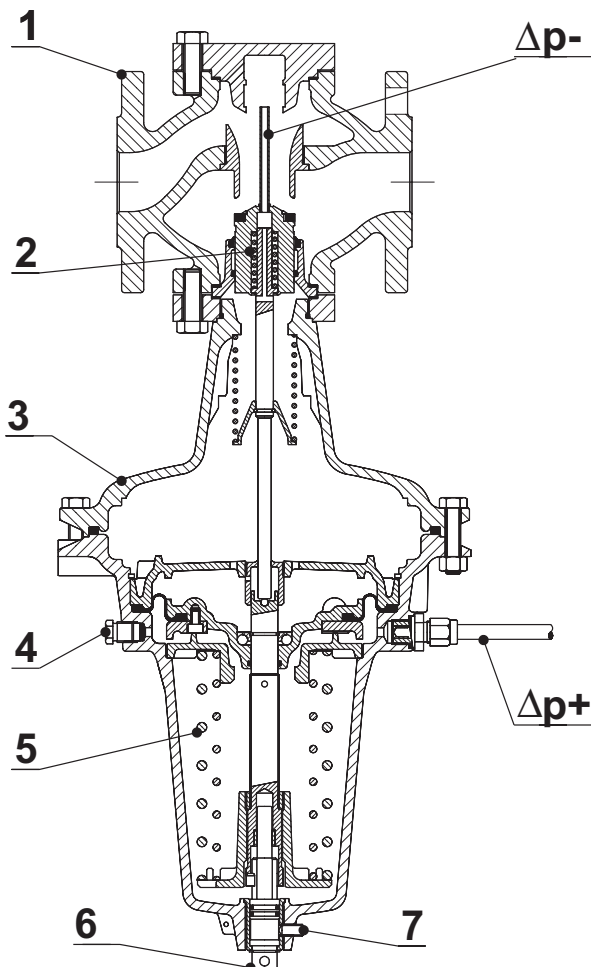

1. Valve
2. Safety spring
3. Diaphragm actuator
4. Venting screws
5. Working spring
6. Adjustment screw
7. Fixing screw

Installation

The controller must be installed in the return pipe. It is recommended to install the controller in horizontal pipeline with actuator body downwards. Installation of a strainer upstream of the valve is recommended. When filling, vent the actuator body by using the venting screws. The direction of the flow is shown by the arrow on the valve body. Connect capillary pipes (copper $\text{Ø}10 \times 1$) always laterally to the pipe.

Keeping the differential pressure over a control valve constant

Heat exchanger

The controller should be mounted downstream the control valve and STAF upstream the control valve, but downstream the heat exchanger.

STAF can be mounted in the supply pipe, but with a decreased valve authority as a consequence.

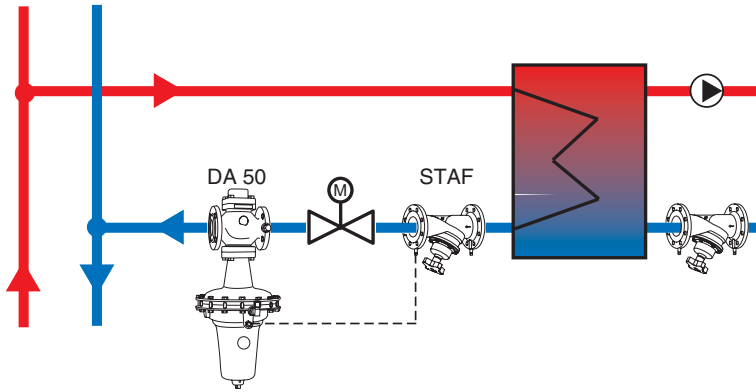

Setting

Differential pressure adjustment

Release fixing screw. Adjust differential pressure by turning the adjustment screw. To increase the differential pressure, turn the screw clockwise (bottom view of screw). At the end, tighten the fixing screw.

Sizing

1. Select the smallest size for the designed flow according to the diagram.
2. Check that the available Δp is bigger than the pressure drop of the DA 50 at the designed flow. The pressure drop can be found in the diagram or calculated by the formula:

$$\Delta p = \left(\frac{q}{100 \times Kvs} \right)^2 \quad (\text{kPa, l/h})$$

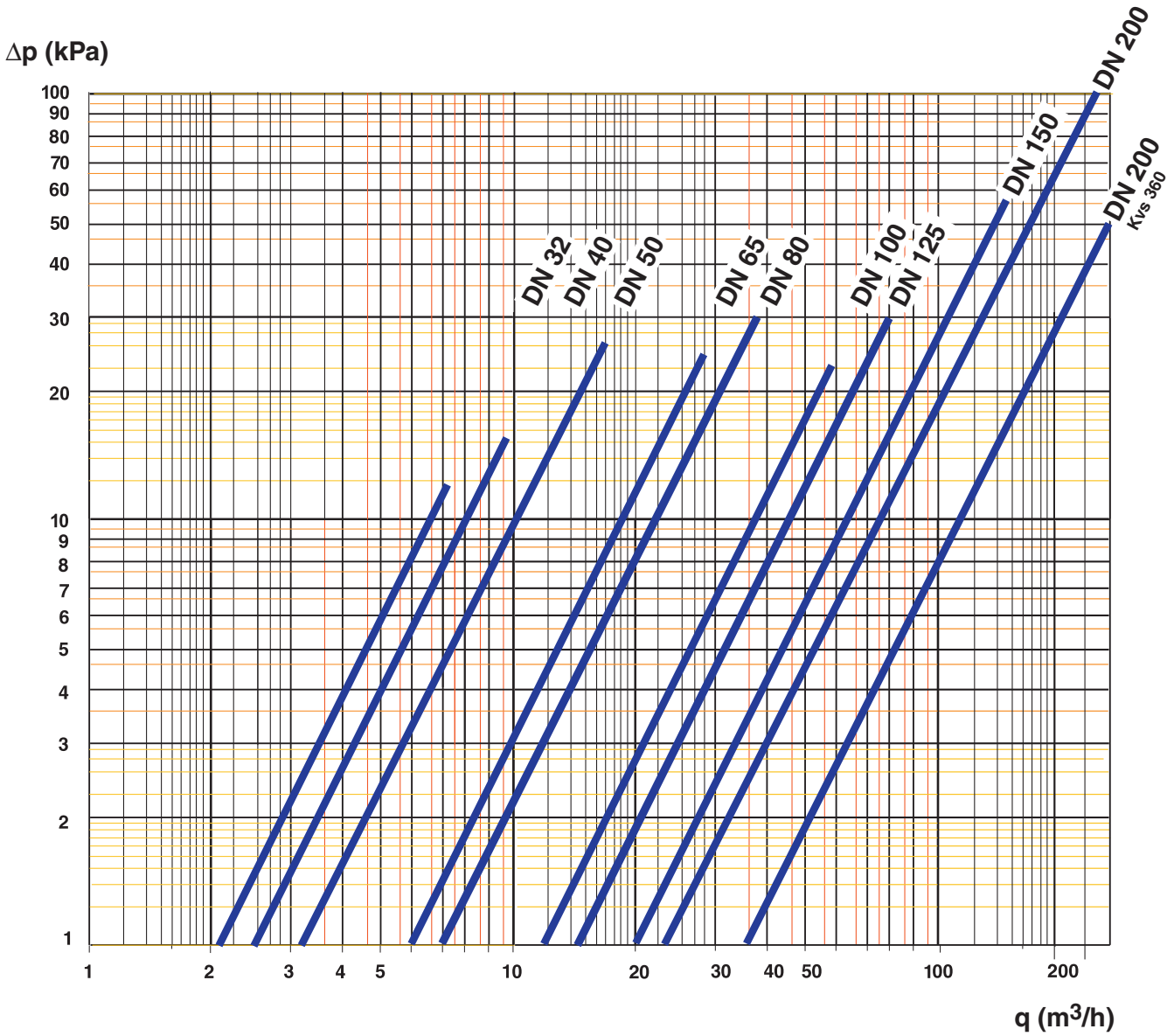

Accessories

Balancing valve STAF, STAF-SG

For flow measuring

Max 120°C

See catalogue leaflet STAF, STAF-SG,... for complete details.

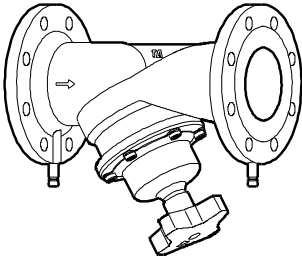

TA No	TA No	DN
PN 16	PN 25	
-	52 182-032**	32
-	52 182-040**	40
-	52 182-050**	50
52 181-065	52 182-065	65
52 181-080	52 182-080	80
52 181-090	52 182-090	100
52 181-091	52 182-091	125
52 181-092	52 182-092	150
52 181-093	52 182-093	200

**) Fit PN 16 flanges.

Measuring point, two-way

For connection of 10 mm copper pipe (STAF) while permitting simultaneous use of TA-CBI/TA-CMI.

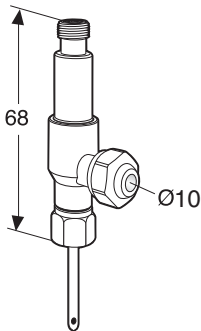

TA No
52 179-210

Measuring point

Max 120°C (Intermittent 150°C)

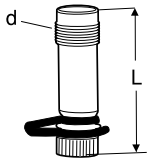

TA No	d	L
52 179-009	R1/4	39
52 179-609	R1/4	103
52 179-008	R3/8	39
52 179-608	R3/8	103

Products for higher temperatures - contact TA.

Other products, see TA Product catalogue section "Balancing valves".

