

Floor Control Set



Floor Heating Controller
For constant control of the
supply temperature

*Engineering
GREAT Solutions*

Floor Control Set

The Floor Control Set with return addition is used for the constant control of the supply temperature for floor heating systems. In addition, with the Floor Control Set, the return addition makes it possible to operate floor heating systems in combination with a heating circuit with a higher temperature level at low temperature.



Technical description

Floor Control Set for constant control of the supply temperature of floor heating systems with a lower temperature range, in combination with a heating circuit with a higher temperature level (e. g. 80°/60°C) (e. g. 176°F/140°F).

The set consists of a thermostatic valve body, a thermostatic head with a contact sensor, a Mikrotherm manual valve as a bypass valve and an electrical pipe contact safety switch as a temperature monitor.

All components are tuned to each other and are available in 4 different sets for floor areas of different sizes.

Construction

Thermostatic valve body

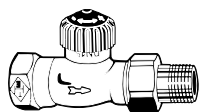

Mikrotherm manual valve

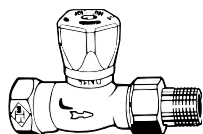

Thermostatic head

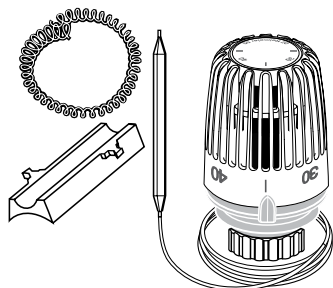

**Elect. pipe contact safety switch
(temperature monitor)**



Application

The Floor Control Set with return addition is used for the constant control of the supply temperature for floor heating systems. In addition, with the Floor Control Set, the return addition makes it possible to operate floor heating systems in combination with a heating circuit with a higher temperature level at low temperature.

In combined floor-radiator heating systems, the floor heating system only supplies part of the room heating requirements. Here, the main function of the system is to heat cold floor

surfaces, e. g. with tiles. The system can also be used to maintain a constant surface temperature e. g. in swimming pools.

In individual cases, the system can be used to meet the overall room heating requirements. The individual room temperature is controlled by thermostatic valves with remote dials, or by thermal or motorized actuators with the appropriate room thermostats.

Sample application

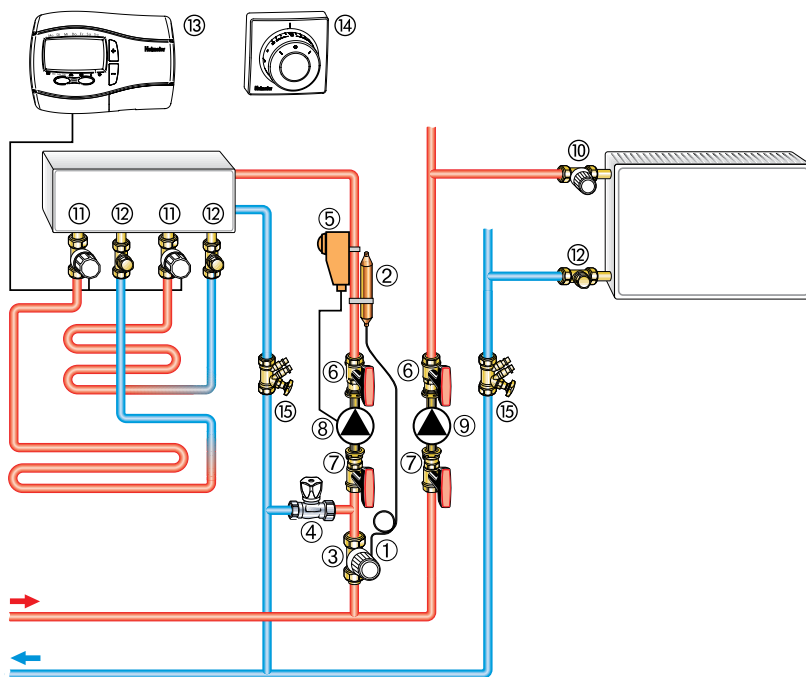

1. Thermostatic head with contact sensor number 20–30–40–50
2. Contact sensor with heat conducting base
3. Thermostatic valve body
4. Manual valve in the bypass
5. Electrical pipe contact safety switch 20–90°C (68°F–194°F)
6. Globo P-S pump ball valve
7. Globo P pump ball valve
8. Pump for floor heating
9. Pump for radiator heating
10. Thermostatic valve
11. Thermostatic valve with EMO T thermal actuator
12. Lockshield
13. Thermostat P
14. Remote dial thermostatic head F
15. STAD balancing valve

Note

The contents of the heat transfer medium should comply with VDI guideline 2035 on damage and scale deposit formation in warm water heating systems.

For industrial and long-distance energy systems, see the applicable codes VdTÜV and 1466/AGFW FW 510.

A heat transfer medium containing mineral oils, or any type of lubricant containing mineral oil can have extremely negative

effects on the source apparatus and usually leads to the disintegration of EPDM seals.

When using nitrite-free frost and corrosion resistance solutions with an ethylene glycol base, pay close attention to the details outlined in the manufacturers' documentation, particularly details concerning concentration and specific additives.

Function

By mixing the heating water from the boiler and the bypass, (4.) the supply temperature in the floor heating circuit is kept constant within a proportional band width required by heating technology. The supply temperature changes are transferred to the contact sensor by a heat conducting base (2.). The pipe

contact safety switch (5.) shuts down the circulating pump (8.) as soon as a deviation from the set permitted value occurs. Depending on the situation in the system, a check should be carried out as to whether additional reverse flow restrictors, gravity brakes or water insulation loops should be installed.

Heating adjustment

The floor heating system should be adjusted with a high boiler temperature.

Fully open the bypass valve and set the thermostatic valve to the required supply temperature for the floor heating system. If this temperature is not reached on the contact sensor, the bypass valve should be gradually opened until the required temperature is reached.

If the supply to the floor heating system does not reach the required temperature:

- The operating temperature of the heat generating device is too low in relation to the heating plan
- The bypass valve has been opened too far
- The set temperature on the pipe contact controller is lower than the setting on the thermostatic valve (pump off)
- Any shut-off devices which may be in the system are closed

Technical data

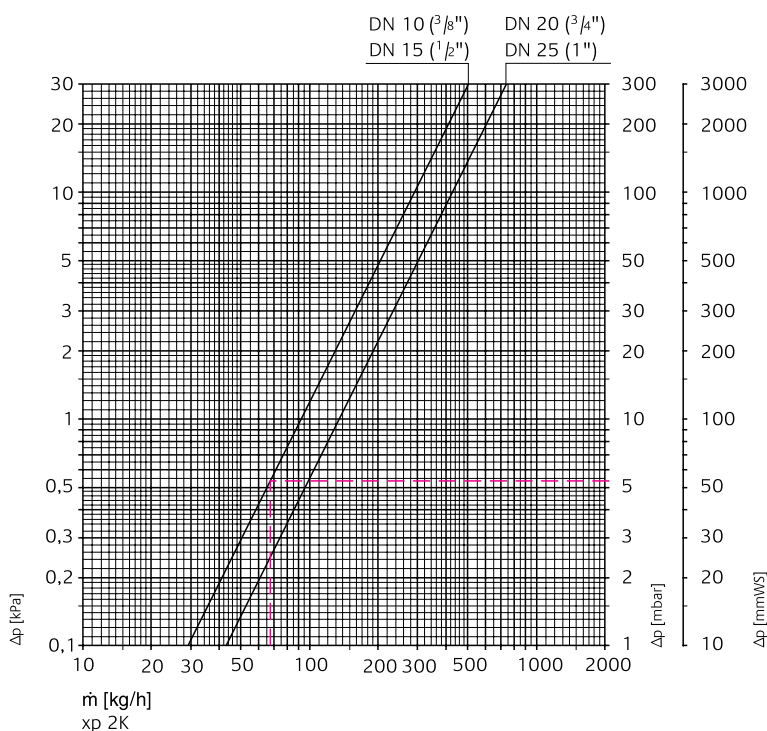

Thermostatic head with valve body	Kv-value (with P-band 2K)	Kvs	Permitted operating temperature TB [°C]	Permitted operating pressure PB [bar]	Permitted differential pressure when the valve is still closed Δp [bar]
DN 10 (3/8") straight	0,92	1,8	120	10	0,80
DN 15 (1/2") straight	0,92	2,5	120	10	0,80
DN 20 (3/4") straight	1,35	4,5	120	10	0,25
DN 25 (1") straight	1,35	5,7	120	10	0,25

Sample calculation

Target:
Size of the Floor Control Set
Thermostatic valve pressure loss Δp_v

Given:
Floor area to be heated: $A = 35 \text{ m}^2$
Heat flow including floor loss: $Q = 2650 \text{ W}$
Temperature spread floor heating system: $\Delta t = 8 \text{ K (44/36}^\circ\text{C)}$
Supply temperature heat generating device: $t_v = 70^\circ\text{C}$

Solution:
Control set size 1, since $A < 45 \text{ m}^2$
Thermostatic valve DN 10 (see "Article numbers")
Mass flow thermostatic valve: $m_v = Q / (c \cdot \Delta t) = 2650 / (1,163 \cdot (70-36)) = 67 \text{ kg/h}$
Pressure loss from diagram $\Delta p_v = 5,4 \text{ mbar}$

$$C_v = \frac{K_v}{0,86}$$

$$K_v = C_v \cdot 0,86$$

Articles

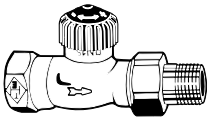

Set 1 - Floor surface: to 45 m²

Parts	Setting area	DN	Part No	EAN	Article No
Thermostatic valve body		10 (3/8")	2242-01.000		
Mikrotherm manual valve		15 (1/2")	0122-02.500		
Thermostatic head with contact sensor	20-50°C		6402-00.500		
Electrical pipe contact safety switch	20-90°C		1991-00.000		
	NC 1-2: 16(2,5)A/250V AC; NO 1-3: 2,5A/250V AC				
Complete set				4024052295012	9690-01.000

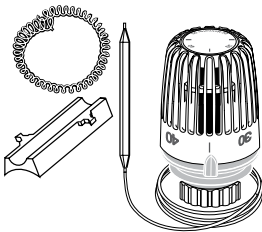

Set 2 - Floor surface: to 85 m²

Parts	Setting area	DN	Part No	EAN	Article No
Thermostatic valve body		15 (1/2")	2242-02.000		
Mikrotherm manual valve		20 (3/4")	0122-03.500		
Thermostatic head with contact sensor	20-50°C		6402-00.500		
Electrical pipe contact safety switch	20-90°C		1991-00.000		
	NC 1-2: 16(2,5)A/250V AC; NO 1-3: 2,5A/250V AC				
Complete set				4024052295111	9690-02.000

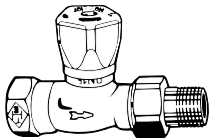

Set 3 - Floor surface: to 120 m²

Parts	Setting area	DN	Part No	EAN	Article No
Thermostatic valve body		20 (3/4")	2242-03.000		
Mikrotherm manual valve		25 (1")	0122-04.500		
Thermostatic head with contact sensor	20-50°C		6402-00.500		
Electrical pipe contact safety switch	20-90°C		1991-00.000		
	NC 1-2: 16(2,5)A/250V AC; NO 1-3: 2,5A/250V AC				
Complete set				4024052295210	9690-03.000



Set 4 - Floor surface: to 160 m²

Parts	Setting area	DN	Part No	EAN	Article No
Thermostatic valve body		25 (1")	2202-04.000		
Mikrotherm manual valve		32 (1 1/4")	0122-05.500		
Thermostatic head with contact sensor	20-50°C		6402-00.500		
Electrical pipe contact safety switch	20-90°C		1991-00.000		
	NC 1-2: 16(2,5)A/250V AC; NO 1-3: 2,5A/250V AC				
Complete set				4024052295319	9690-04.000

